

CS 110

Computer Architecture

Running a Program - CALL

(Compiling, Assembling,

Linking, and Loading)

Instructor:
Sören Schwertfeger

<http://shtech.org/courses/ca/>

School of Information Science and Technology SIST

ShanghaiTech University

Slides based on UC Berkley's CS61C

Levels of Representation/Interpretation

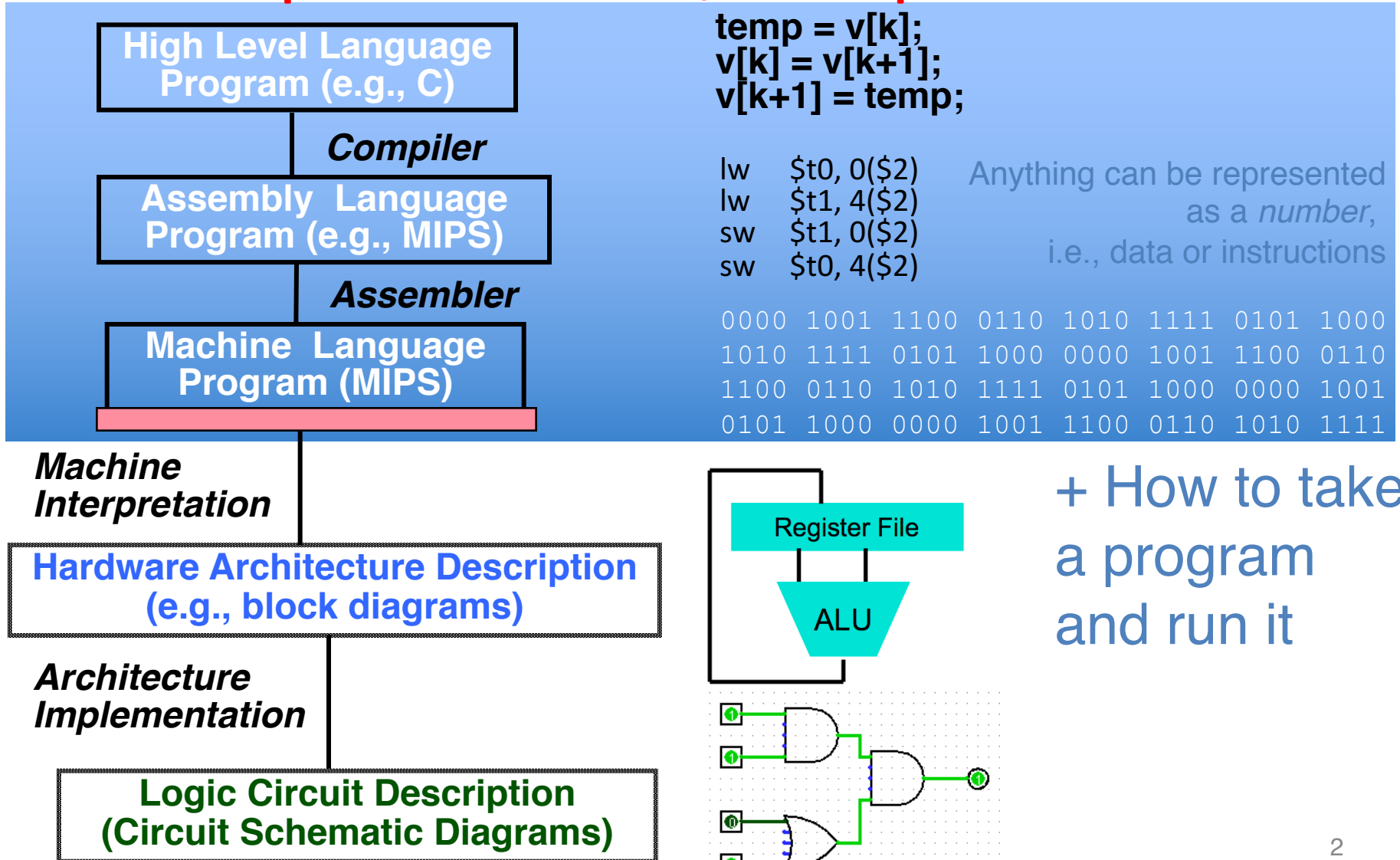

Language Execution Continuum

- An **Interpreter** is a program that executes other programs.

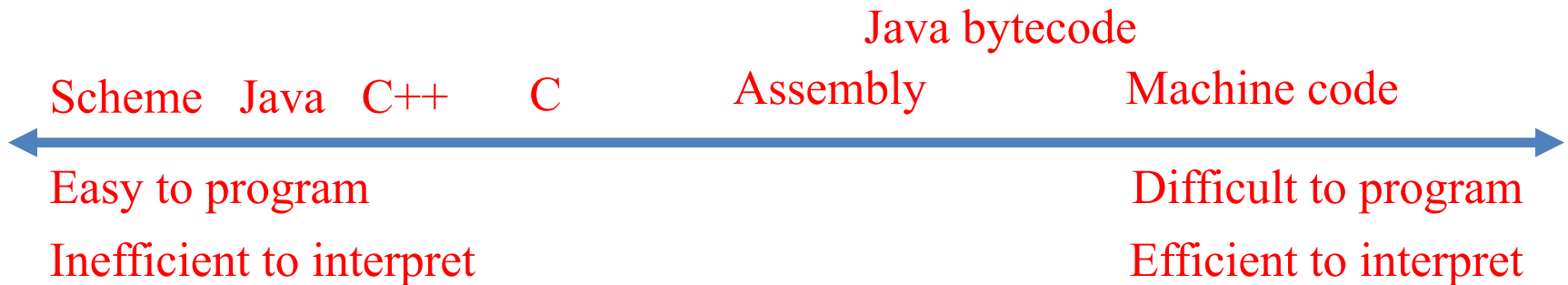

- Language **translation** gives us another option
- In general, we **interpret** a high-level language when efficiency is not critical and **translate** to a lower-level language to increase performance

Interpretation vs Translation

- How do we run a program written in a source language?
 - **Interpreter**: Directly executes a program in the source language
 - **Translator**: Converts a program from the source language to an equivalent program in another language
- For example, consider a Python program **foo.py**

Interpretation

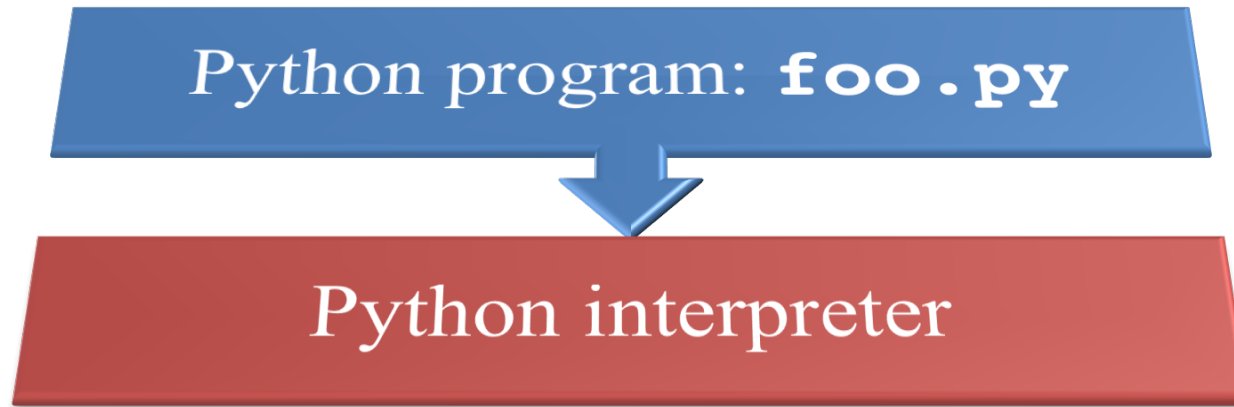

- Python interpreter is just a program that reads a python program and performs the functions of that python program.

Interpretation

- Any good reason to interpret machine language in software?
- MARS– useful for learning / debugging
- Apple Macintosh conversion
 - Switched from Motorola 680x0 instruction architecture to PowerPC.
 - Similar issue with switch to x86
 - Could require all programs to be re-translated from high level language
 - Instead, let executables contain old and/or new machine code, interpret old code in software if necessary (emulation)

Interpretation vs. Translation? (1/2)

- Generally easier to write interpreter
- Interpreter closer to high-level, so can give better error messages (e.g., MARS)
 - Translator reaction: add extra information to help debugging (line numbers, names)
- Interpreter slower (10x?), code smaller (2x?)
- Interpreter provides instruction set independence: run on any machine

Interpretation vs. Translation? (2/2)

- Translated/compiled code almost always more efficient and therefore higher performance:
 - Important for many applications, particularly operating systems.
- Translation/compilation helps “hide” the program “source” from the users:
 - One model for creating value in the marketplace (eg. Microsoft keeps all their source code secret)
 - Alternative model, “open source”, creates value by publishing the source code and fostering a community of developers.

Steps in compiling a C program

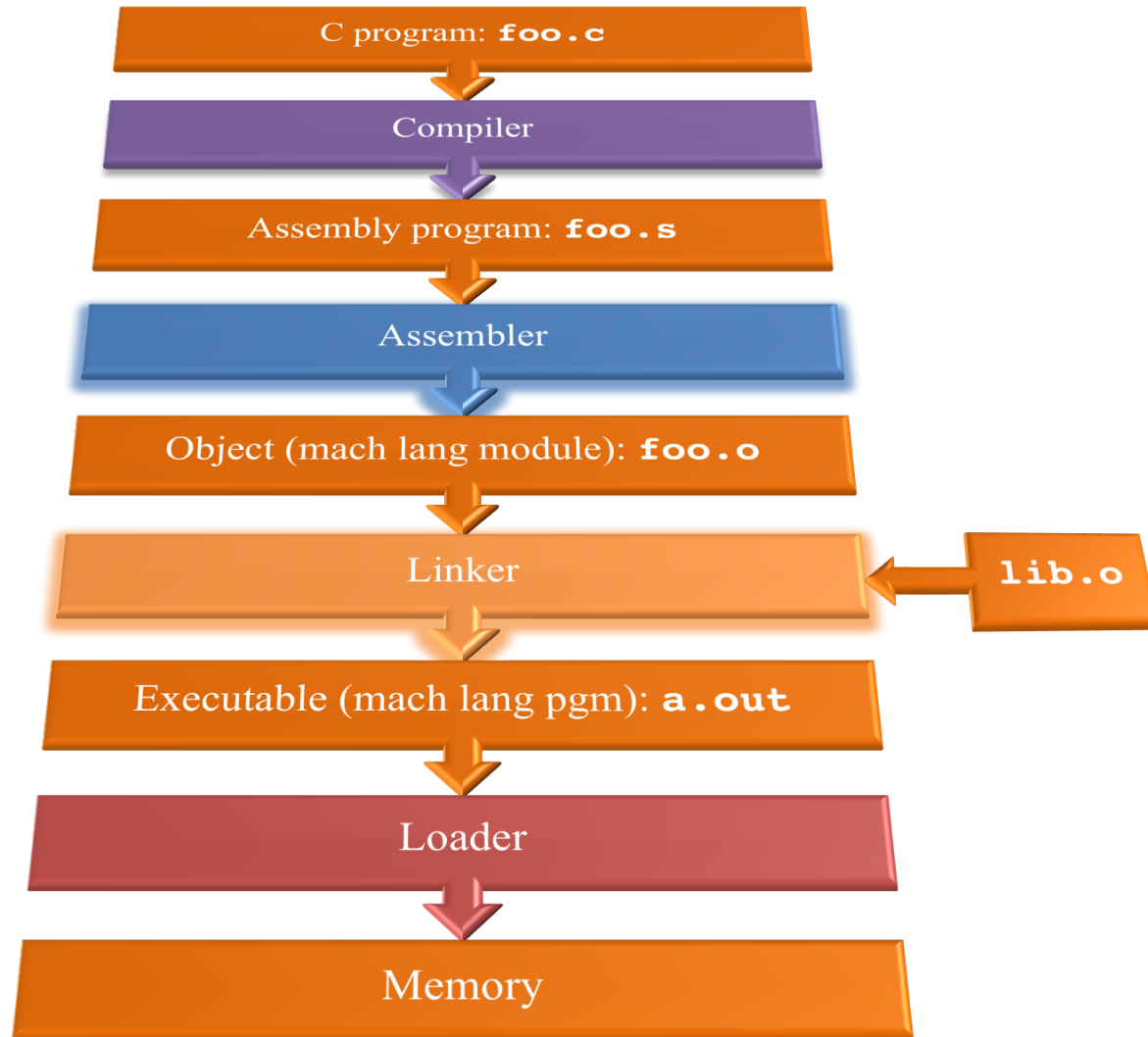

Compiler

- Input: High-Level Language Code (e.g., **foo.c**)
- Output: Assembly Language Code (e.g., **foo.s** for MIPS)
- Note: Output *may* contain pseudo-instructions
- Pseudo-instructions: instructions that assembler understands but not in machine
For example:
 - **move \$s1, \$s2** \Rightarrow **add \$s1, \$s2, \$zero**

Where Are We Now?

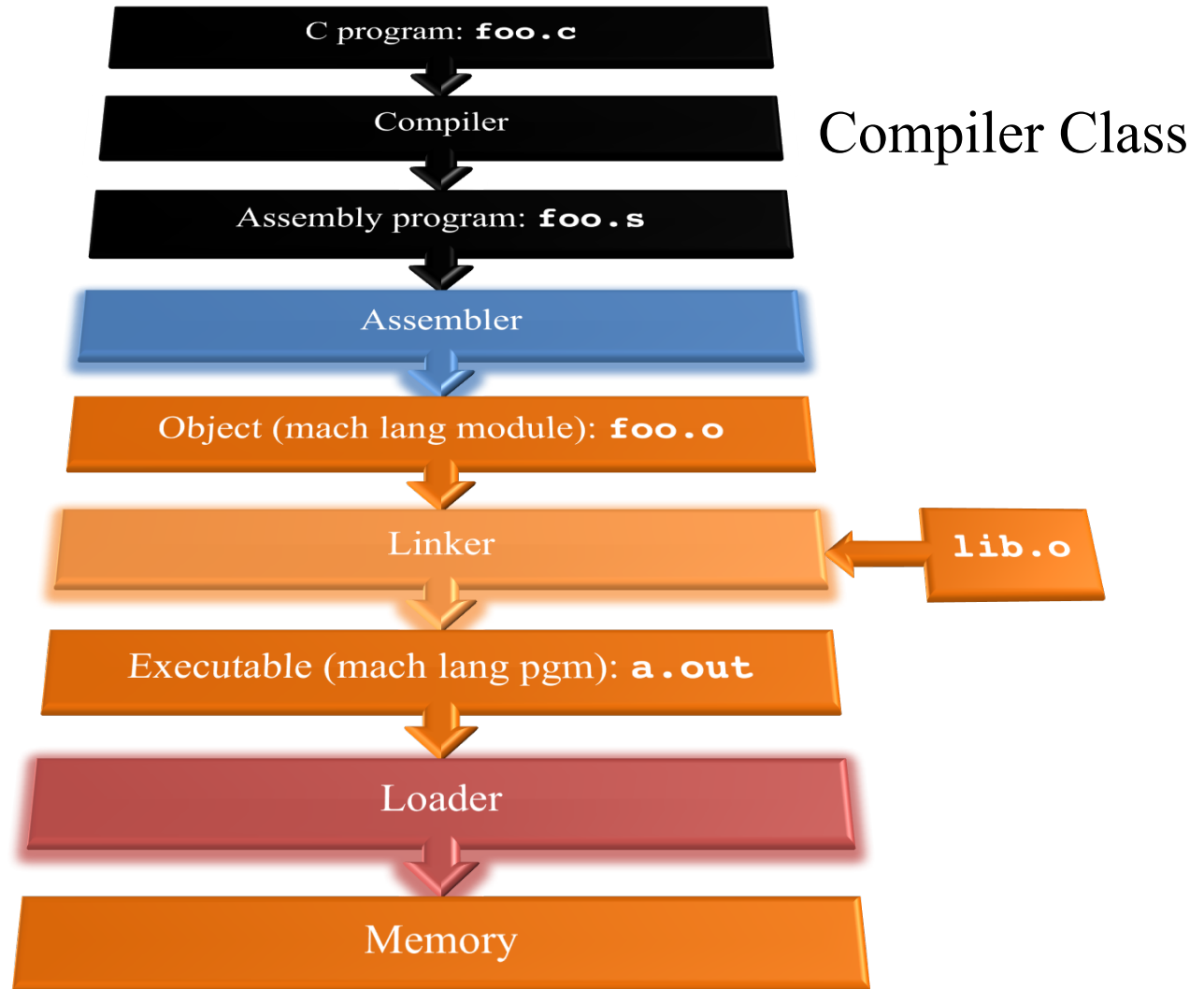

Assembler

- Input: Assembly Language Code (MAL)
(e.g., **foo.s** for MIPS)
- Output: Object Code, information tables (TAL)
(e.g., **foo.o** for MIPS)
- Reads and Uses **Directives**
- Replace Pseudo-instructions
- Produce Machine Language
- Creates **Object File**

Assembler Directives (p. A-13.. A-17)

- Give directions to assembler, but do not produce machine instructions
 - **.text**: Subsequent items put in user text segment (machine code)
 - **.data**: Subsequent items put in user data segment (binary rep of data in source file)
 - **.globl sym**: declares **sym** global and can be referenced from other files
 - **.ascii str**: Store the string **str** in memory and null-terminate it
 - **.word w1...wn**: Store the n 32-bit quantities in successive memory words

Pseudo-instruction Replacement

- Assembler treats convenient variations of machine language instructions as if real instructions

Pseudo:

```
subu $sp,$sp,32
```

```
sd $a0, 32($sp)
```

```
mul $t7,$t6,$t5
```

```
addu $t0,$t6,1
```

```
ble $t0,100,loop
```

```
la $a0, str
```

Real:

```
addiu $sp,$sp,-32
```

```
sw $a0, 32($sp)
```

```
sw $a1, 36($sp)
```

```
mult $t6,$t5
```

```
mflo $t7
```

```
addiu $t0,$t6,1
```

```
slti $at,$t0,101
```

```
bne $at,$0,loop
```

```
lui $at,left(str)
```

```
ori $a0,$at,right(str)
```

Question

Which of the following is a correct TAL instruction sequence for `la $v0, FOO`?

`%hi(label)`, tells assembler to fill upper 16 bits of label's addr

`%lo(label)`, tells assembler to fill lower 16 bits of label's addr

A: `ori $v0, %hi(FOO)`
`addiu $v0, %lo(FOO)`

D: `lui $v0, %hi(FOO)`
`ori $v0, %lo(FOO)`

B: `ori $v0, %lo(FOO)`
`lui $v0, %hi(FOO)`

E: `la $v0, FOO` is already a TAL instruction

C: `lui $v0, %lo(FOO)`
`ori $v0, %hi(FOO)`

*Assume the address of FOO is 0xABCD0124

Producing Machine Language (1/3)

- Simple Case
 - Arithmetic, Logical, Shifts, and so on
 - All necessary info is within the instruction already
- What about Branches?
 - PC-Relative
 - So once pseudo-instructions are replaced by real ones, we know by how many instructions to branch
- So these can be handled

Producing Machine Language (2/3)

- “Forward Reference” problem
 - Branch instructions can refer to labels that are “forward” in the program:

```
        or    $v0, $0, $0
L1:     slt   $t0, $0, $a1
        beq   $t0, $0, L2
        addi  $a1, $a1, -1
        j     L1
L2:     add   $t1, $a0, $a1
```

- Solved by taking 2 passes over the program
 - First pass remembers position of labels
 - Second pass uses label positions to generate code

Producing Machine Language (3/3)

- What about jumps (**j** and **jal**)?
 - Jumps require **absolute address**
 - So, forward or not, still can't generate machine instruction without knowing the position of instructions in memory
- What about references to static data?
 - **la** gets broken up into **lui** and **ori**
 - These will require the full 32-bit address of the data
- These can't be determined yet, so we create two tables...

Symbol Table

- List of “items” in this file that may be used by other files
- What are they?
 - Labels: function calling
 - Data: anything in the **.data** section; variables which may be accessed across files

Relocation Table

- List of “items” this file needs the address of later
- What are they?
 - Any label jumped to: **j** or **jal**
 - internal
 - external (including lib files)
 - Any piece of data in static section
 - such as the **la** instruction

Object File Format

- object file header: size and position of the other pieces of the object file
- text segment: the machine code
- data segment: binary representation of the static data in the source file
- relocation information: identifies lines of code that need to be fixed up later
- symbol table: list of this file's labels and static data that can be referenced
- debugging information
- A standard format is ELF (except MS)

Admin

- HW 3 will be published this week (MIPS Assembly programming)
- Project 1.1 will be published this week (program an Assembler in C)
 - Send the TA of your lab a mail with subject "[CA]" and body:
 - Additional, external email address (the new gradebot key will be send there)
 - The email addresses of the two team members.

Where Are We Now?

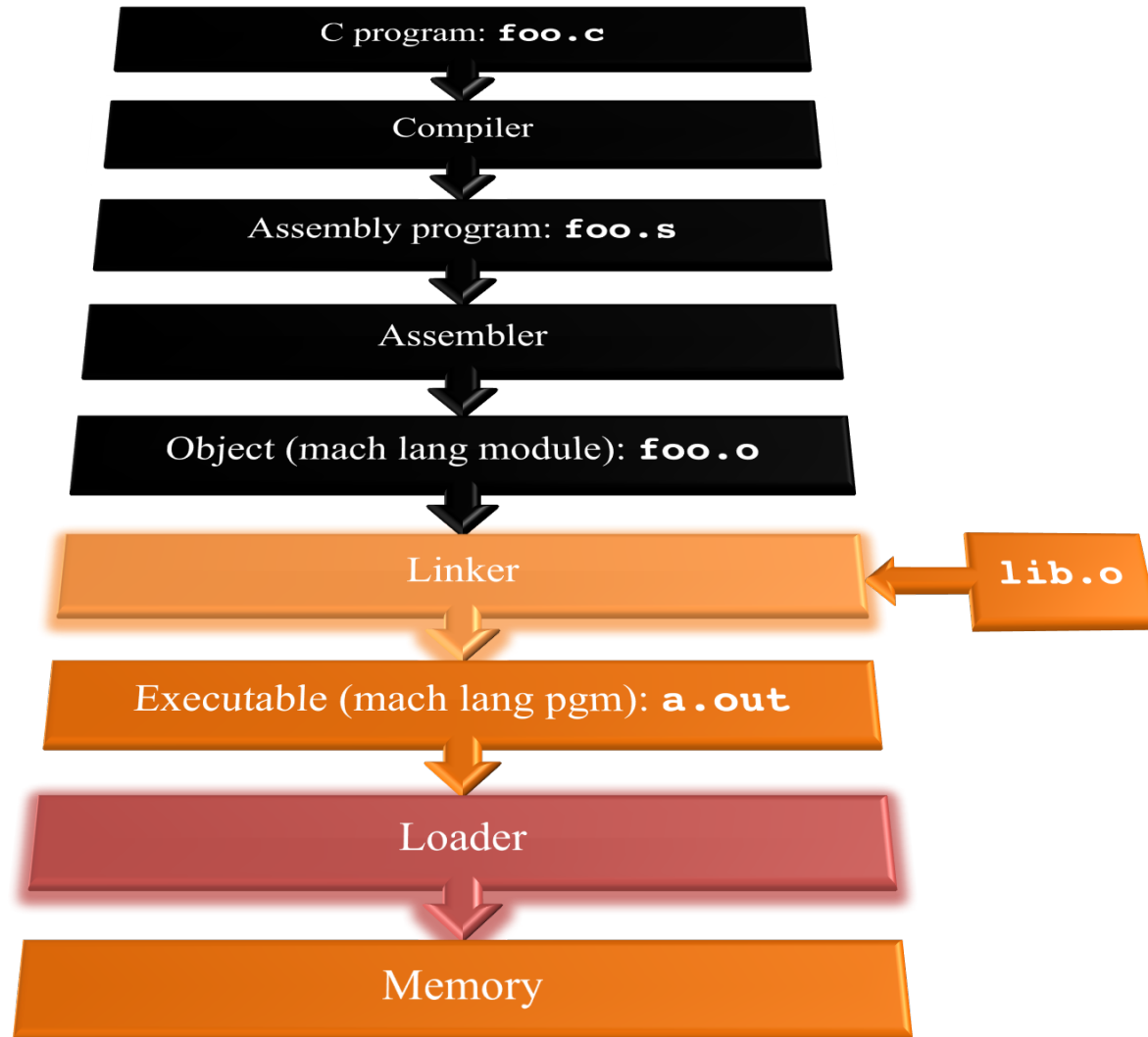

Linker (1/3)

- Input: Object code files, information tables (e.g., `foo.o`, `libc.o` for MIPS)
- Output: Executable code (e.g., `a.out` for MIPS)
- Combines several object (`.o`) files into a single executable (“[linking](#)”)
- Enable separate compilation of files
 - Changes to one file do not require recompilation of the whole program
 - Windows NT source was > 40 M lines of code!
 - Old name “Link Editor” from editing the “links” in jump and link instructions

Linker (2/3)

.o file 1

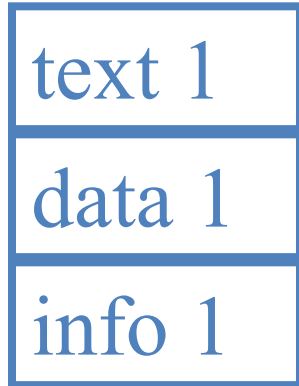

.o file 2

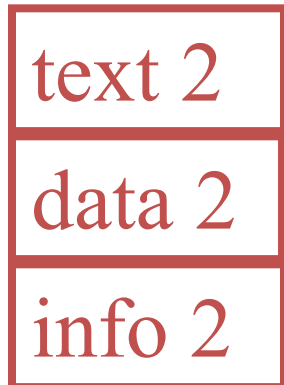

a.out



Linker (3/3)

- Step 1: Take text segment from each .o file and put them together
- Step 2: Take data segment from each .o file, put them together, and concatenate this onto end of text segments
- Step 3: Resolve references
 - Go through Relocation Table; handle each entry
 - That is, fill in all **absolute addresses**

Four Types of Addresses

- PC-Relative Addressing (`beq`, `bne`)
 - never relocate
- Absolute Function Address (`j`, `jal`)
 - always relocate
- External Function Reference (usually `jal`)
 - always relocate
- Static Data Reference (often `lui` and `ori`)
 - always relocate

Absolute Addresses in MIPS

- Which instructions need relocation editing?
 - J-format: jump, jump and link

j/jal	xxxxxx
--------------	---------------

- Loads and stores to variables in static area, relative to global pointer

lw/sw	\$gp	\$x	address
--------------	-------------	------------	----------------

- What about conditional branches?

beq/bne	\$rs	\$rt	address
----------------	-------------	-------------	----------------

- PC-relative addressing **preserved** even if code moves

Resolving References (1/2)

- Linker **assumes** first word of first text segment is at address **0x04000000**.
 - (More later when we study “virtual memory”)
- Linker knows:
 - length of each text and data segment
 - ordering of text and data segments
- Linker calculates:
 - absolute address of each label to be jumped to (internal or external) and each piece of data being referenced

Resolving References (2/2)

- To resolve references:
 - search for reference (data or label) in all “user” symbol tables
 - if not found, search library files (for example, for **printf**)
 - once absolute address is determined, fill in the machine code appropriately
- Output of linker: executable file containing text and data (plus header)

Where Are We Now?

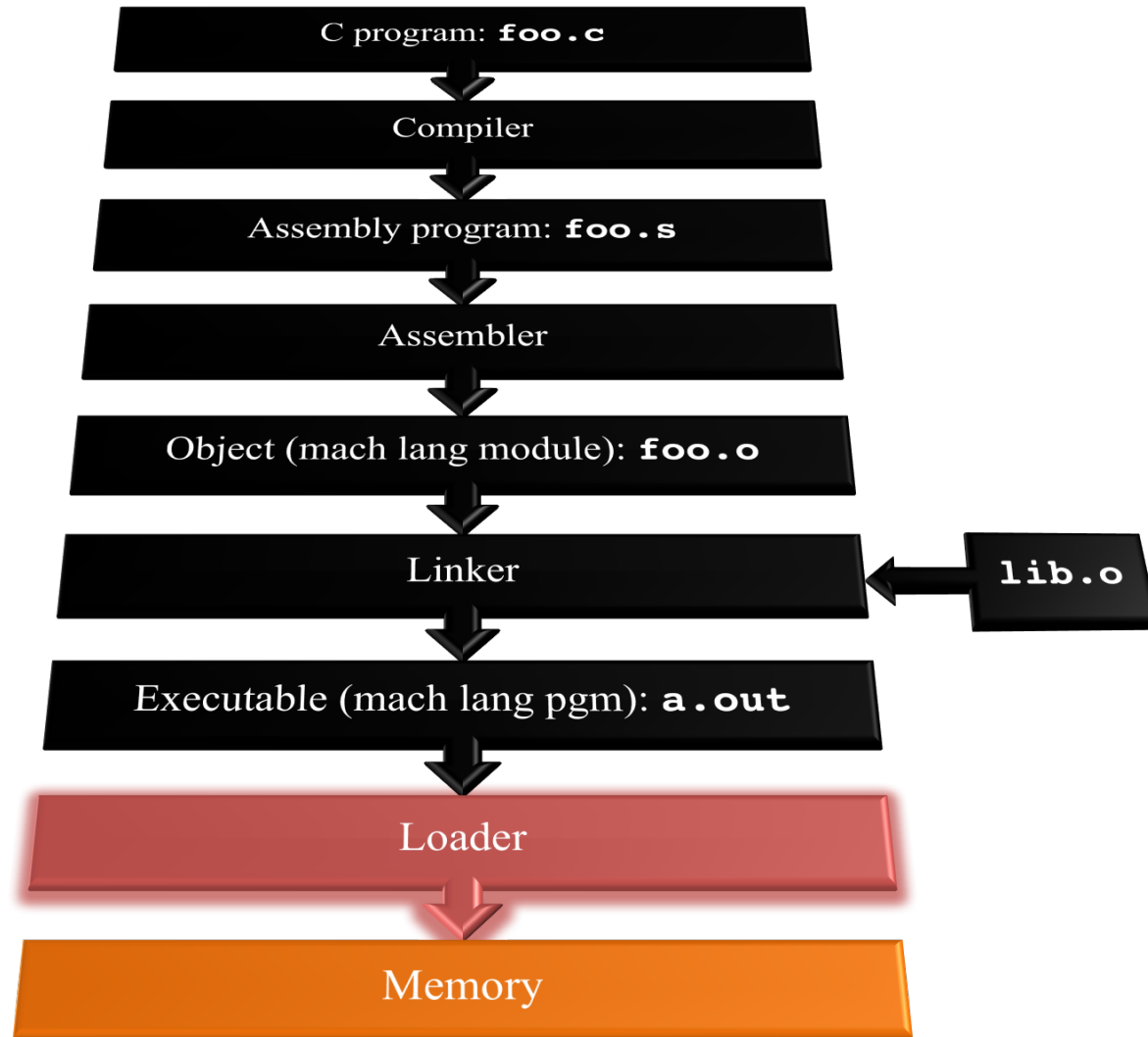

Loader Basics

- Input: Executable Code
(e.g., **a.out** for MIPS)
- Output: (program is run)
- Executable files are stored on disk
- When one is run, loader's job is to load it into memory and start it running
- In reality, loader is the operating system (OS)
 - loading is one of the OS tasks

Loader ... what does it do?

- Reads executable file's header to determine size of text and data segments
- Creates new address space for program large enough to hold text and data segments, along with a stack segment
- Copies instructions and data from executable file into the new address space
- Copies arguments passed to the program onto the stack
- Initializes machine registers
 - Most registers cleared, but stack pointer assigned address of 1st free stack location
- Jumps to start-up routine that copies program's arguments from stack to registers & sets the PC
 - If main routine returns, start-up routine terminates program with the exit system call

Question

At what point in process are all the machine code bits generated for the following assembly instructions:

1) `addu $6, $7, $8`

2) `jal fprintf`

A: 1) & 2) After compilation

B: 1) After compilation, 2) After assembly

C: 1) After assembly, 2) After linking

D: 1) After assembly, 2) After loading

E: 1) After compilation, 2) After linking

Example: C \Rightarrow Asm \Rightarrow Obj \Rightarrow Exe \Rightarrow Run

C Program Source Code: prog.c

```
#include <stdio.h>
int main (int argc, char *argv[]) {
    int i, sum = 0;
    for (i = 0; i <= 100; i++)
        sum = sum + i * i;
    printf ("The sum of sq from 0 .. 100 is
    %d\n",    sum);
}
```

“printf” lives in “libc”

Compilation: MAL

```
.text
.align 2
.globl main
main:
    subu $sp,$sp,32
    sw $ra, 20($sp)
    sd $a0, 32($sp)
    sw $0, 24($sp)
    sw $0, 28($sp)
loop:
    lw $t6, 28($sp)
    mul $t7, $t6,$t6
    lw $t8, 24($sp)
    addu $t9,$t8,$t7
    sw $t9, 24($sp)
```

```
    addu $t0, $t6, 1
    sw $t0, 28($sp)
    ble $t0,100, loop
    la $a0, str
    lw $a1, 24($sp)
    jal printf
    move $v0, $0
    lw $ra, 20($sp)
    addiu $sp,$sp,32
    jr $ra
.data
    .align 0
str:
    .asciiz "The sum
of sq from 0 ..
100 is %d\n"
```

**Where are
7 pseudo-
instructions?**

Compilation: MAL

```
.text
.align 2
.globl main
main:
subu $sp,$sp,32
sw $ra, 20($sp)
sd $a0, 32($sp)
sw $0, 24($sp)
sw $0, 28($sp)
loop:
lw $t6, 28($sp)
mul $t7,$t6,$t6
lw $t8, 24($sp)
addu $t9,$t8,$t7
sw $t9, 24($sp)
```

```
addu $t0,$t6,1
sw $t0, 28($sp)
ble $t0,100,loop
la $a0, str
lw $a1, 24($sp)
jal printf
move $v0,$0
lw $ra, 20($sp)
addiu $sp,$sp,32
jr $ra
.data
.align 0
str:
.asciiz "The sum
of sq from 0 ..
100 is %d\n"
```

7 pseudo-instructions underlined

Assembly step 1:

Remove pseudoinstructions, assign addresses

<u>00</u>	<u>addiu</u>	<u>\$29, \$29, -32</u>	<u>30</u>	<u>addiu</u>	<u>\$8, \$14, 1</u>
04	sw	\$31, 20(\$29)	34	sw	\$8, 28(\$29)
08	sw	\$4, 32(\$29)	38	slti	\$1, \$8, 101
0c	sw	\$5, 36(\$29)	3c	bne	\$1, \$0, loop
10	sw	\$0, 24(\$29)	40	lui	\$4, l.str
14	sw	\$0, 28(\$29)	44	ori	\$4, \$4, r.str
18	lw	\$14, 28(\$29)	48	lw	\$5, 24(\$29)
1c	multu	\$14, \$14	4c	jal	printf
20	mflo	\$15	50	add	\$2, \$0, \$0
24	lw	\$24, 24(\$29)	54	lw	\$31, 20(\$29)
28	addu	\$25, \$24, \$15	58	addiu	\$29, \$29, 32
2c	sw	\$25, 24(\$29)	5c	jr	\$31

Assembly step 2

Create relocation table and symbol table

- Symbol Table

Label	address (in module)	type
<code>main:</code>	<code>0x00000000</code>	<code>global text</code>
<code>loop:</code>	<code>0x00000018</code>	<code>local text</code>
<code>str:</code>	<code>0x00000000</code>	<code>local data</code>

- Relocation Information

Address	Instr. type	Dependency
<code>0x00000040</code>	<code>lui</code>	<code>l.str</code>
<code>0x00000044</code>	<code>ori</code>	<code>r.str</code>
<code>0x0000004c</code>	<code>jal</code>	<code>printf</code>

Assembly step 3

Resolve local PC-relative labels

```
00 addiu $29,$29,-32
04 sw    $31,20($29)
08 sw    $4, 32($29)
0c sw    $5, 36($29)
10 sw    $0, 24($29)
14 sw    $0, 28($29)
18 lw    $14, 28($29)
1c multu $14, $14
20 mflo  $15
24 lw    $24, 24($29)
28 addu  $25,$24,$15
2c sw    $25, 24($29)
30 addiu $8,$14, 1
34 sw    $8,28($29)
38 slti  $1,$8, 101
3c bne   $1,$0, -10
40 lui   $4, l.str
44 ori   $4,$4,r.str
48 lw    $5,24($29)
4c jal   printf
50 add   $2, $0, $0
54 lw    $31,20($29)
58 addiu $29,$29,32
5c jr    $31
```

Assembly step 4

- Generate object (.o) file:
 - Output binary representation for
 - text segment (instructions)
 - data segment (data)
 - symbol and relocation tables
 - Using dummy “placeholders” for unresolved absolute and external references

Text segment in object file

```
0x000000 0010011110111101111111111111000000
0x000004 101011111011111100000000000010100
0x000008 101011111010010000000000000100000
0x00000c 1010111110100101000000000000100100
0x000010 1010111110100000000000000000011000
0x000014 1010111110100000000000000000011100
0x000018 1000111110101110000000000000011100
0x00001c 1000111110111000000000000000011000
0x000020 0000000111001110000000000000011001
0x000024 001001011100100000000000000000001
0x000028 001010010000000010000000000001100101
0x00002c 1010111110101000000000000000011100
0x000030 0000000000000000000000111100000010010
0x000034 0000001100000111111001000000100001
0x000038 0001010000010000001111111111110111
0x00003c 1010111110111001000000000000011000
0x000040 001111000000010000000000000000000
0x000044 100011111010010100000000000000000
0x000048 0000110000001000000000000000011101100
0x00004c 001001000000000000000000000000000
0x000050 1000111110111111000000000000010100
0x000054 00100111101111010000000000000100000
0x000058 00000011111000000000000000000001000
0x00005c 0000000000000000000000001000000100001
```

Link step 1: combine `prog.o`, `libc.o`

- Merge text/data segments
- Create absolute memory addresses
- Modify & merge symbol and relocation tables

- Symbol Table

– Label	Address	
<code>main:</code>	<code>0x00000000</code>	
<code>loop:</code>	<code>0x00000018</code>	
<code>str:</code>	<code>0x10000430</code>	
<code>printf:</code>	<code>0x000003b0</code>	...

- Relocation Information

– Address	Instr. Type	Dependency	
<code>0x00000040</code>	<code>lui</code>	<code>l.str</code>	
<code>0x00000044</code>	<code>ori</code>	<code>r.str</code>	
<code>0x0000004c</code>	<code>jal</code>	<code>printf</code>	...

Link step 2:

- Edit Addresses in relocation table
 - (shown in TAL for clarity, but done in binary)

```
00 addiu $29,$29,-32
04 sw$31,20($29)
08 sw$4, 32($29)
0c sw$5, 36($29)
10 sw $0, 24($29)
14 sw $0, 28($29)
18 lw $14, 28($29)
1c multu $14, $14
20 mflo $15
24 lw $24, 24($29)
28 addu $25,$24,$15
2c sw $25, 24($29)
```

```
30 addiu $8,$14, 1
34 sw$8,28($29)
38 slti $1,$8, 101
3c bne $1,$0, -10
40 lui $4, 4096
44 ori $4,$4,1072
48 lw$5,24($29)
4c jal 944
50 add $2, $0, $0
54 lw $31,20($29)
58 addiu $29,$29,32
5c jr$31
```

Link step 3:

- Output executable of merged modules
 - Single text (instruction) segment
 - Single data segment
 - Header detailing size of each segment
- NOTE:
 - The preceding example was a much simplified version of how ELF and other standard formats work, meant only to demonstrate the basic principles.

Static vs Dynamically linked libraries

- What we've described is the traditional way: **statically-linked** approach
 - The library is now part of the executable, so if the library updates, we don't get the fix (have to recompile if we have source)
 - It includes the entire library even if not all of it will be used
 - Executable is self-contained
- An alternative is **dynamically linked libraries** (DLL), common on Windows (.dll) & UNIX (.so) platforms

Dynamically linked libraries

- Space/time issues
 - + Storing a program requires less disk space
 - + Sending a program requires less time
 - + Executing two programs requires less memory (if they share a library)
 - At runtime, there's time overhead to do link
- Upgrades
 - + Replacing one file (`libXYZ.so`) upgrades every program that uses library “XYZ”
 - Having the executable isn't enough anymore

Overall, dynamic linking adds quite a bit of complexity to the compiler, linker, and operating system. However, it provides many benefits that often outweigh these

Dynamically linked libraries

- The prevailing approach to dynamic linking uses machine code as the “lowest common denominator”
 - The linker does not use information about how the program or library was compiled (i.e., what compiler or language)
 - This can be described as “linking at the machine code level”
 - This isn’t the only way to do it ...

In Conclusion...

- Compiler converts a single HLL file into a single assembly language file.
- Assembler removes pseudo-instructions, converts what it can to machine language, and creates a checklist for the linker (relocation table). A `.s` file becomes a `.o` file.
 - Does 2 passes to resolve addresses, handling internal forward references
- Linker combines several `.o` files and resolves absolute addresses.
 - Enables separate compilation, libraries that need not be compiled, and resolves remaining addresses
- Loader loads executable into memory and begins execution.

